

User Manual

SmartyCam 3 Sport Release 1.00





INDEX

1 – SmartyCam 3 Sport topics	2
2 – SmartyCam 3 Sport connections	4
3 – SmartyCam 3 Sport buttons, ON/OFF, powering	6
3.1 - Pushbuttons	6
3.2 – Power ON/OFF	7
4 – SD card management	7
5 – SmartyCam 3 Sport Start/Stop recording	8
6 – SmartyCam 3 Sport Menu	9
6.1 – GPS Status	9
6.2 – Tracks	10
6.2.1 – Loading tracks to SmartyCam 3 Sport	11
6.2.2 – Managing tracks on SmartyCam 3 Sport	11
6.3 – Settings	12
6.3.1 – Auto Start Rec	12
6.3.2 – Auto Stop Rec	12
6.3.3 – Auto power off	13
6.3.4 – Exposure set	13
6.3.5 – Audio set	13
6.3.6 – Upside Down (montata al contrario)	14
6.3.7 – Overlay	14
6.3.8 – System time	14
6.3.9 – Rec Counter	15
6.3.10 – LOG Files Export	15
6.3.11 – Info	15
6.3.12 – Factory RST	15
6.4 – Update	15
6.4.1 – Firmup	16
6.4.2 – Tracks update	16
6.5 – Video file	17
7 – SmartyCam 3 Sport and the PC	18
7.1 – Creating SmartyCam 3 Sport configuration	18
7.1.1 – Configuring SmartyCam 3 Sport overlay	19
7.1.2 – Logo and MAP Setting	21
7.1.3 – Configuring SmartyCam 3 Sport parameters	22
7.1.4 –SmartyCam 3 Sport connected to a master	23
7.4 – Loading the configuration to SmartyCam 3 Sport	26
7.5 – Track Management	27
7.6 – Video Management	29
8 – Technical specifications and drawings	32



1 – SmartyCam 3 Sport topics

Wide Global Shutter CMOS sensor

The best way to avoid wave effects when vibrations are strong.



Standard action camera

Full HD image

1920 x 1080 resolution, at 30 fps

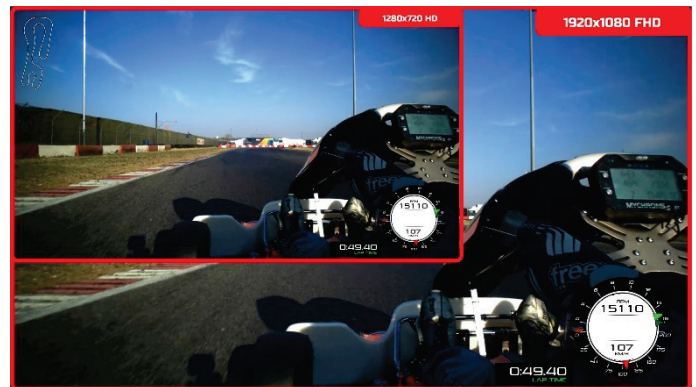

Completely waterproof

Designed for being used in the hardest environments: water, dust, temperatures are not a problem.

Sapphire frontal glass

The strongest glass for facing all high-speed impacts with pebbles, insects, dust that usually happen in a race.





A lot of graphic controls

Choose your preferred layout for keeping your data under control



Auto start/stop recording

Avoid thinking at the camera while ready at the starting line.

Automatic track selection

SmartyCam 3 Sport automatically receives the track selected by the connected AiM logger or selects the right track in its database if not connected to any AiM device in order to easily draw it and calculate lap number, lap times and rolling times.

Video and data in the same file

Your video and the most important data in the same MP4 file.

Automatic data and video synchronization

In case the data stored in the MP4 are not enough for your analysis, simply import the video file and the data from your AiM logger and the software will automatically synchronize them: position on the track, video frame and data on the graph will be perfectly correlated

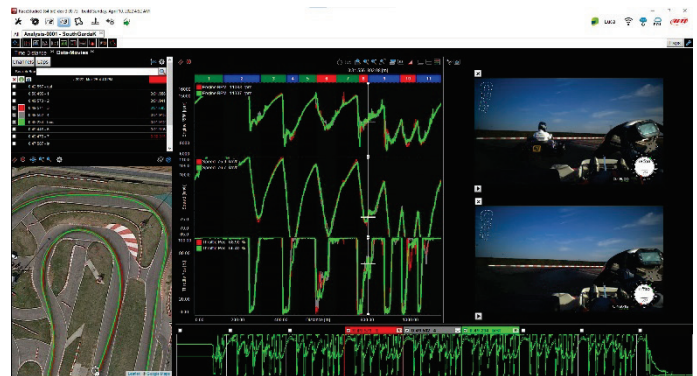

2 – SmartyCam 3 Sport connections

SmartyCam 3 Sport has an internal battery that may keep the system alive for a few minutes (around 20 min), so it is important to power it through an external 12 Volt battery, directly or through an AiM logger, using the 5 pins connector placed on the back of the camera, as shown in the pictures here down.

To connect SmartyCam 3 Sport to GPS Module (optional) use the 5 pins Binder 712 female connector you find back on the camera and connect it to the 2 ways Data Hub needed to power the camera. SmartyCam 3 Sport can as well be connected to AiM Dashes and loggers through the AiM CAN network. The images below show some examples of connection.

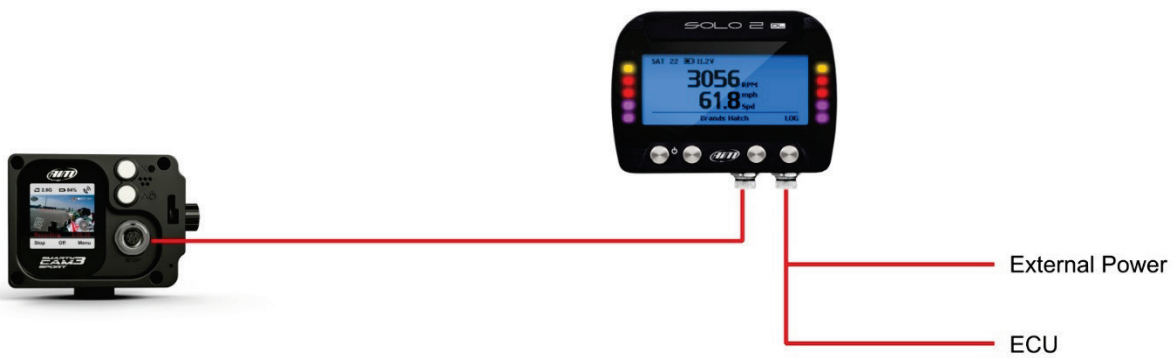

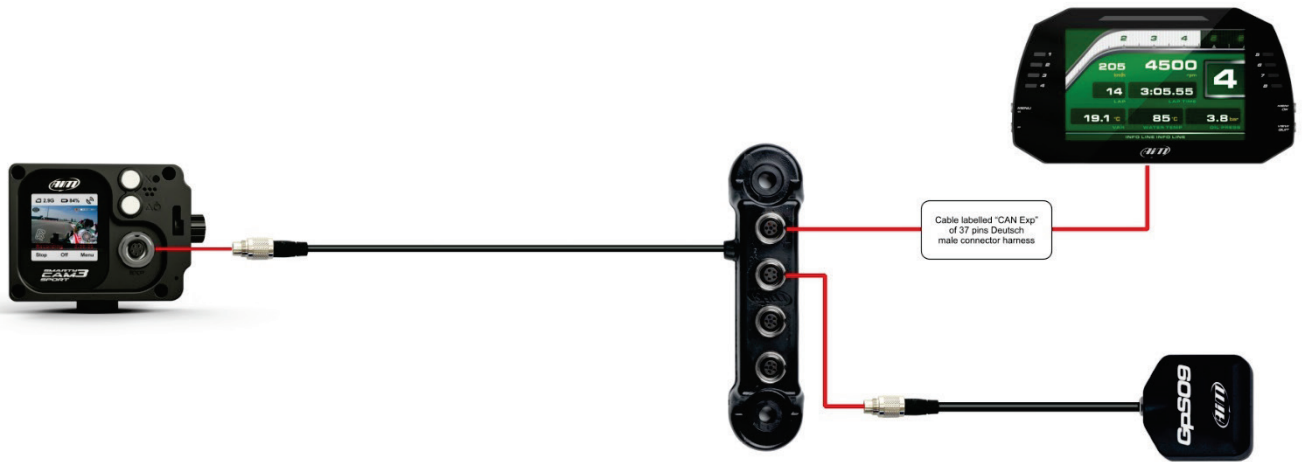

3 – SmartyCam 3 Sport buttons, ON/OFF, powering

3.1 - Pushbuttons

SmartyCam 3 Sport features two metal pushbuttons on its back, each of which manages two different features, shown bottom on the display.



The upper pushbutton manages the features corresponding to these icons icons:

- "X": short pressure
- ●: long pressure

While the lower pushbutton manages the features corresponding to these icons icons:

- △: short pressure
- ⏻: long pressure to turn OFF

3.2 – Power ON/OFF

SmartyCam 3 Sport powers ON when:

- You push the lower pushbutton
- An external power turns ON

It turns OFF after a period of inactivity, that you can set in the menu following this path: "MENU>>SETTINGS>>AUTO POWER OFF. Available options are:

- 5 min
- 15 min
- 30 min
- 1 hour

To charge SmartyCam 3 Sport internal battery plug the battery charger into the rear 712 Binder female connector. This charger is included in the kit



4 – SD card management

SmartyCam 3 Sport can support up to 2 TB MicroSD cards. The MicroSD is used not only to store video recorded by the camera but also to load the configuration and the firmware to the same camera (see paragraph 6.4 for further information).

The housing is closed by a plastic thumb screw. To open it press and turn the plastic thumb screw clockwise as written on the camera and shown here below. To close the door, firmly shut the flap and press in the thumbscrew then turn it counter clockwise. If SmartyCam 3 Sport is powered a steady red light is shown when the flap is open.



5 – SmartyCam 3 Sport Start/Stop recording

SmartyCam 3 Sport can start/stop recording in manual or in automatic mode.

When SmartyCam 3 Sport is recording the display becomes all red and after a minute it switches off.

Please note: it is always possible to start/stop recording in manual mode pressing “Rec” button. It turns to stop and you can press it to stop (left and central image below).

It is possible to enable the Automatic Start Recording, following this path:

- “MENU →SETTINGS →AUTO START REC →”. Default setting is “Auto” press “Change” to turn to “Manual” (image below on the right).



To set automatic stop recording follow this path: “MENU →SETTINGS →AUTO STOP REC”

Available options are:

- “5 sec”
- “20 sec” (default)
- “1 min”
- “2 min”
- “5 min”

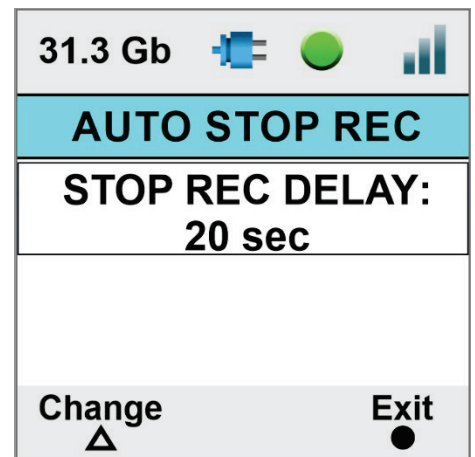

Please note: refer to chapter 7 “SmartyCam 3 Sport and the PC” to know how to set the parameters for automatic start/stop recording.

6 – SmartyCam 3 Sport Menu

SmartyCam 3 Sport settings can be changed through the two pushbutton. Pressing “MENU” this page shows up:

Available options are:

- **GPS STATUS:** status of the connected GPS
- **TRACKS:** to show the list
- **SETTINGS**
- **UPDATE**
- **VIDEO FILE**

In any situation use:

- “Down” (X) button to scroll the options
- “Sel” (Δ) to select and
- “Exit” (●) to quit and save

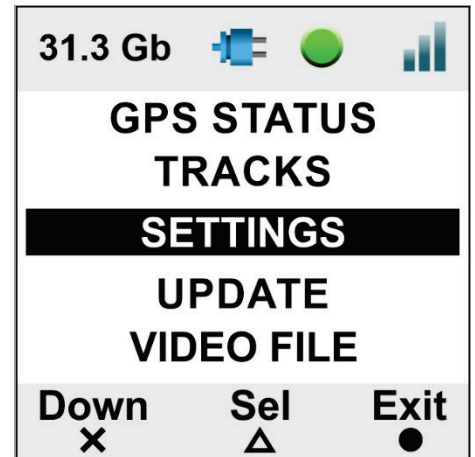

6.1 – GPS Status

Shows the number of connected satellites with the related signal level.

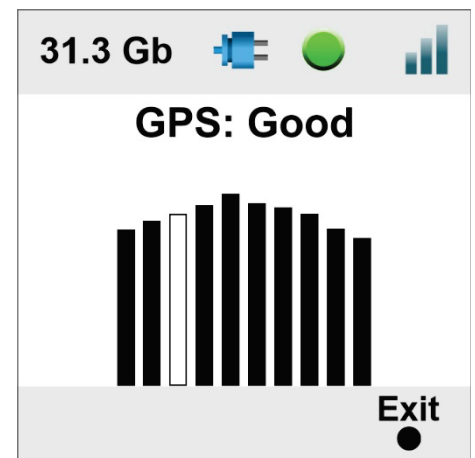

6.2 – Tracks

SmartyCam 3 Sport can show the map of the circuit if loaded in its configuration (see paragraph 7.1.2 for further information) as well as the position of the vehicle on the track.



SmartyCam 3 Sport can be installed in two ways:

- connected to an AiM logger, such as : MyChron5, Solo 2 DL, MX* logger, SW4, PDMs and EVOs; in this case the maps are loaded on AiM logger, that automatically selects the one you are racing on and transmits it to SmartyCam 3 Sport, that shows it in the video, in the position you defined during the configuration (please refer to paragraph 7.1.2 for further information).
- Connected to a GPS Module; in this last case you need to load the track maps directly to SmartyCam 3 Sport using its microSD.

At the very first switch on the camera tells you that there are no tracks (image below) but this is not a problem if SmartyCam 3 Sport is connected to any AiM logger while in case is connected to a GPS Module, you need to load the tracks on it.

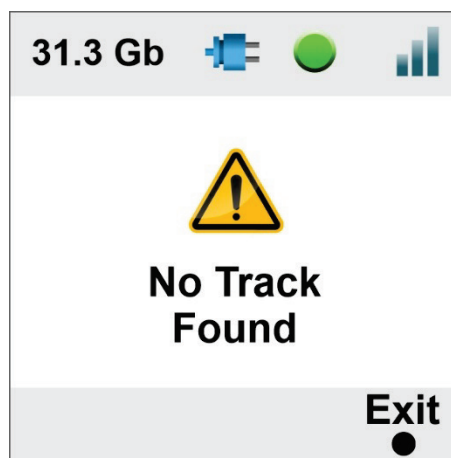

6.2.1 – Loading tracks to SmartyCam 3 Sport

To load tracks on SmartyCam 3 Sport perform these operations:

- place the microSD in SmartyCam3 Sport and power it on to properly format the card and then in the PC slot
- run Race Studio3 software and load the tracks on the MicroSD (refer to paragraph 7.5 for further information)
- insert the microSD in SmartyCam 3 Sport and follow this path: MENU -> UPDATE -> TRACKS
- press "Sel"
- in a few seconds SmartyCam 3 Sport loads the tracks.

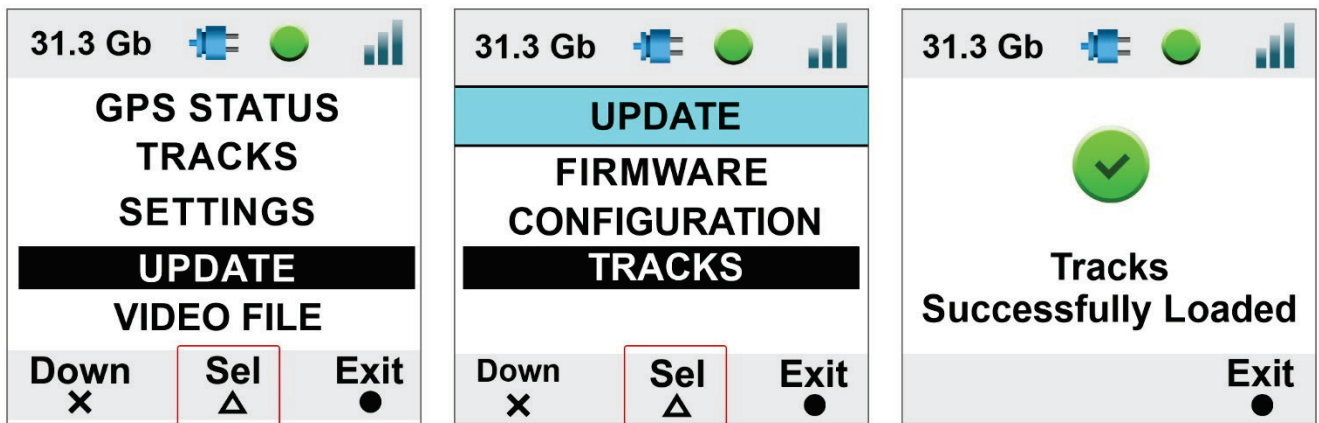

6.2.2 – Managing tracks on SmartyCam 3 Sport

If SmartyCam 3 Sport is not connected to any AiM logger but only to AiM GPS 09 Module track selection can be managed in two ways: automatic (default) and manual

In **AUTO** mode SmartyCam 3 Sport recognizes and selects the map of the circuit you are racing on.

In **MANUAL** mode you need to select the track by yourself. To **manually set a track** on SmartyCam 3 Sport:

- set **MANUAL MODE**
- scroll the track list and locate your track
- press: "Prev"
- press "Sel"

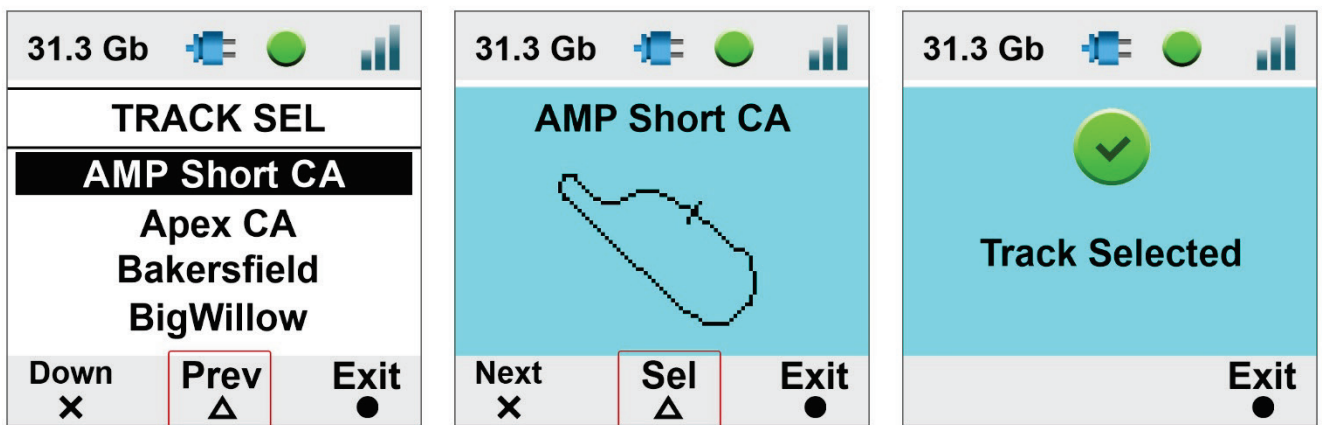

TRACKS Menu allows to **see a preview of the track** and the related information too. This is very useful in case you need to select a specific track configuration among more configurations of the same track as shown here below.

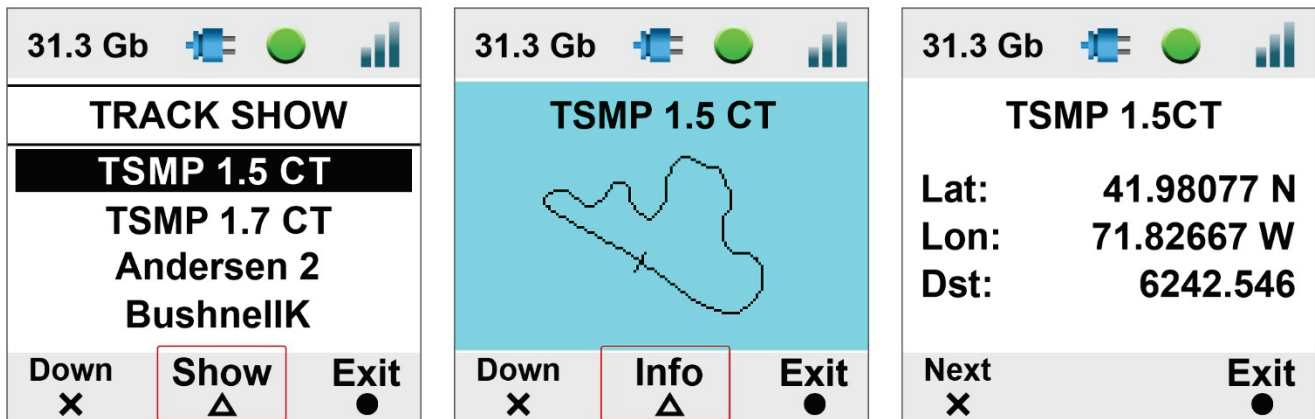

6.3 – Settings

Setting Menu is used for:

- Auto Start Rec
- Auto Stop Rec
- Auto power off
- Exposure set
- Audio Set
- Upside Down
- Overlay
- System Time
- Rec Counter
- Log Files Export
- Info
- Factory Reset
- Clear Tracks

6.3.1 – Auto Start Rec

SmartyCam 3 Sport is enabled for automatically starting and stopping the video recording. This happens in two different ways:

- if connected to an AiM Logger it starts/stops recording when the logger starts/stops recording
- if connected to a GPS 09 Module it starts recording according to the conditions set in configuration. As default, it starts recording when the speed is greater than 10 km/h

6.3.2 – Auto Stop Rec

Auto stop record is a delay to stop the recording after the recording threshold is no longer met; this whether SmartyCam3 Sport is standalone or connected to a dash or logger.

6.3.3 – Auto power off

SmartyCam 3 Sport turns automatically OFF after a time period, here defined, during which no function is used.

6.3.4 – Exposure set

This option allows to set the part of the shot to be used as reference. As shown in the images below:

- use “Change” button to modify the area to be used for adjusting the light. It is shown through a red rectangle. Please, select the whole frame in case of installations in open cockpits.
- use “Exit” button to save and exit

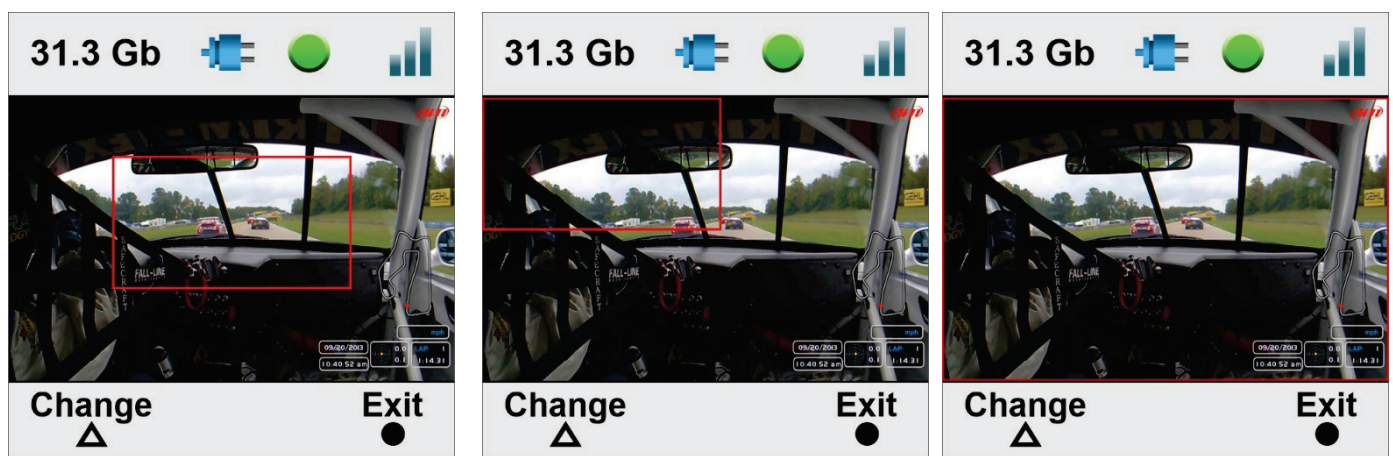

6.3.5 – Audio set

SmartyCam 3 Sport comes with an internal microphone. To set it.

- Use “Change” button to set the gain
- Use “Exit” button to save and exit

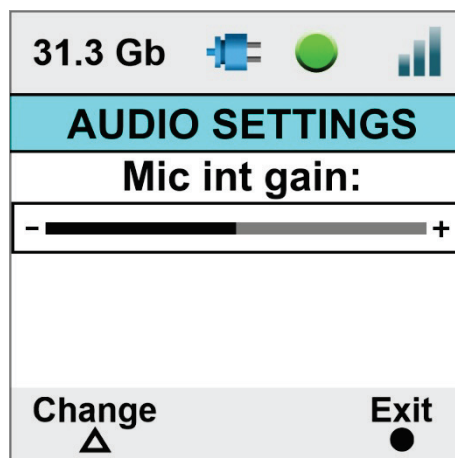

6.3.6 – Upside Down (montata al contrario)

SmartyCam 3 Sport has a standard ¼ thread in its base that is used for mounting it. Sometimes, in closed cars, it is more comfortable to install the camera upside down. In this case, you have to flip the video over.



6.3.7 – Overlay

In case you wish to record a video without Overlays, you may disable them in this voice of the menu.

6.3.8 – System time

SmartyCam 3 Sport has an internal clock powered by a battery and constantly updated by the external GPS 09 Module. Please note that both Time Zone and Saving Time Zone are considered and automatically corrected.

In this Menu Voice you may define different date/time formats:

- 0-12 or 0-24
- DD/MM/YYYY or MM/DD/YYYY



6.3.9 – Rec Counter





















This page shows the number of recording of SmartyCam 3 Sport. Press “Reset” to reset the counter.

6.3.10 – LOG Files Export

Each time SmartyCam3 Sport records a video it creates a LOG FILE containing all the information that can help understanding a possible problem. In case you need help from AiM Support team, please, export the LOG file to the MicroSD and send it to the team.

6.3.11 – Info

The information here shown are important in case you need help from AiM Support Team. “Restore Info” page tells you which firmware release will be restored if you decide to perform a factory reset.

31.3 Gb   	31.3 Gb   	31.3 Gb   	31.3 Gb   
SYSTEM INFO	CONNECTION INFO	HW INFO	RESTORE INFO
Fw-Rel: 00.00.32 Fw-Date: 06/04/2022 Fw-Hour: 17.33 SN: 11112	AiM-SC3 - 11112	Hw Rel: SMC10C Date: 2022-02-17	Rel: 00.00.27 Date: 06/04/2022 Hour: 17.33
Next  Exit 	Next  Exit 	Next  Exit 	Next  Exit 

6.3.12 – Factory RST

Resets SmartyCam 3 Sport to its default values.







6.4 – Update

It allows to update:

- Firmware version
- Configuration
- Tracks

All these elements need to be exported to the MicroSD through AiM RaceStudio 3 software.

Configuration is the overlay transmitted to SmartyCam3 Sport (the camera can load one configuration at a time only).

31.3 Gb   
UPDATE
FIRMWARE
CONFIGURATION
TRACKS
Down  Sel  Exit 

6.4.1 – Firmup

To update SmartyCam 3 Sport firmup:

- run Race Studio 3 and navigate to the top right “web updates” cloud icon
- If there is a new SmartyCam 3 Sport firmware check mark it and click “download”
- load it on the camera micro SD clicking “update device”
- replace the micro SD in its slot in SmartyCam 3 Sport and switch the camera on
- follow this path MENU >> FIRMUP
- the camera shows the available firmware releases
- Select the one you want to install and wait; in a few moments the camera will reboot and the new firmware is installed.

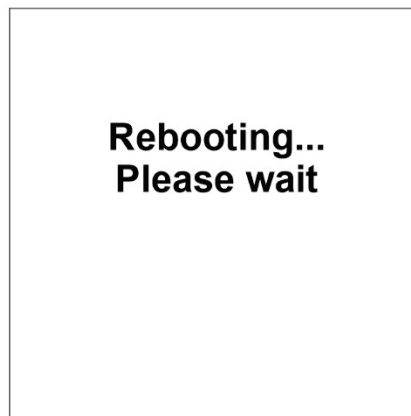
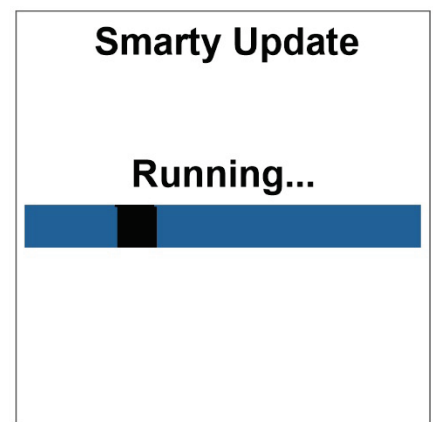
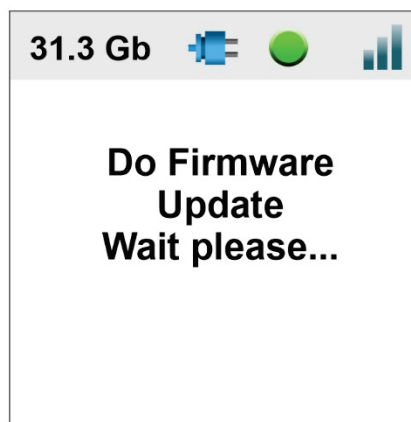
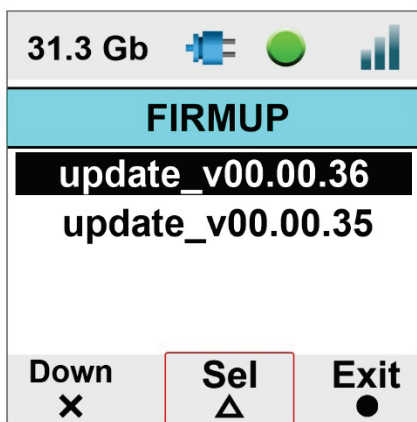

6.4.2 – Tracks update

Please refer to paragraphs 6.2.1 and 7.5.



6.5 – Video file

This page shows the list of video file stored in SmartyCam 3 Sport SD card. Scroll the list and press “Del” to delete any video. SmartyCam 3 Sport asks for confirmation.

31.3 Gb			
VIDEO LIST			
04/15 09:52 2.2M			
04/27 10:44 0.3G			
04/27 13:47 0.4G			
04/28 11:49 0.3G			
Down X	Del △	Exit ●	

7 – SmartyCam 3 Sport and the PC

7.1 – Creating SmartyCam 3 Sport configuration

To create SmartyCam 3 Sport configuration:

- Run Race Studio 3 software
- press “NEW” to create a new configuration
- “New configuration” panel appears
- select “SmartyCam 3 Sport”
- fill in the panel that is prompted and press “OK”

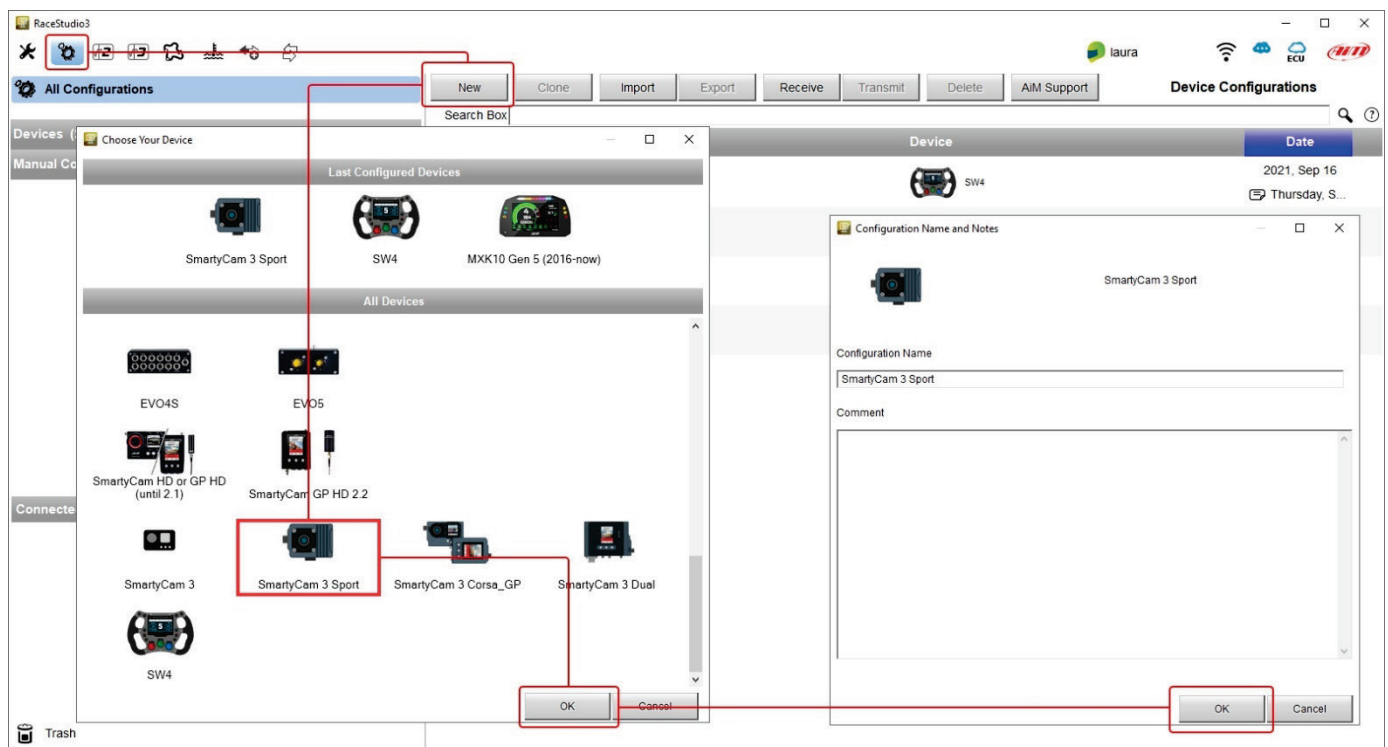

Race Studio 3 software enters directly in SmartyCam 3 Sport overlay layer. The layer layout changes according to the camera working mode.

SmartyCam 3 Sport can be installed in two ways:

- connected to a **MASTER** (any **AiM Logger**): in this case, it must be configured in “**SLAVE MODE**” and will receive all the information to be shown from the logger
- **Standalone**: in this case it is connected to AiM GPS Module only and will show only GPS data (position, speed, accelerations, Lap Number, Lap Time)



If SmartyCam 3 is **standalone**, you only need to set:

- "Overlay" layer
- "Parameters" layer



If, on the contrary, SmartyCam 3 Sport is connected to a master, you also need to set CAN Protocol layer.

7.1.1 – Configuring SmartyCam 3 Sport overlay

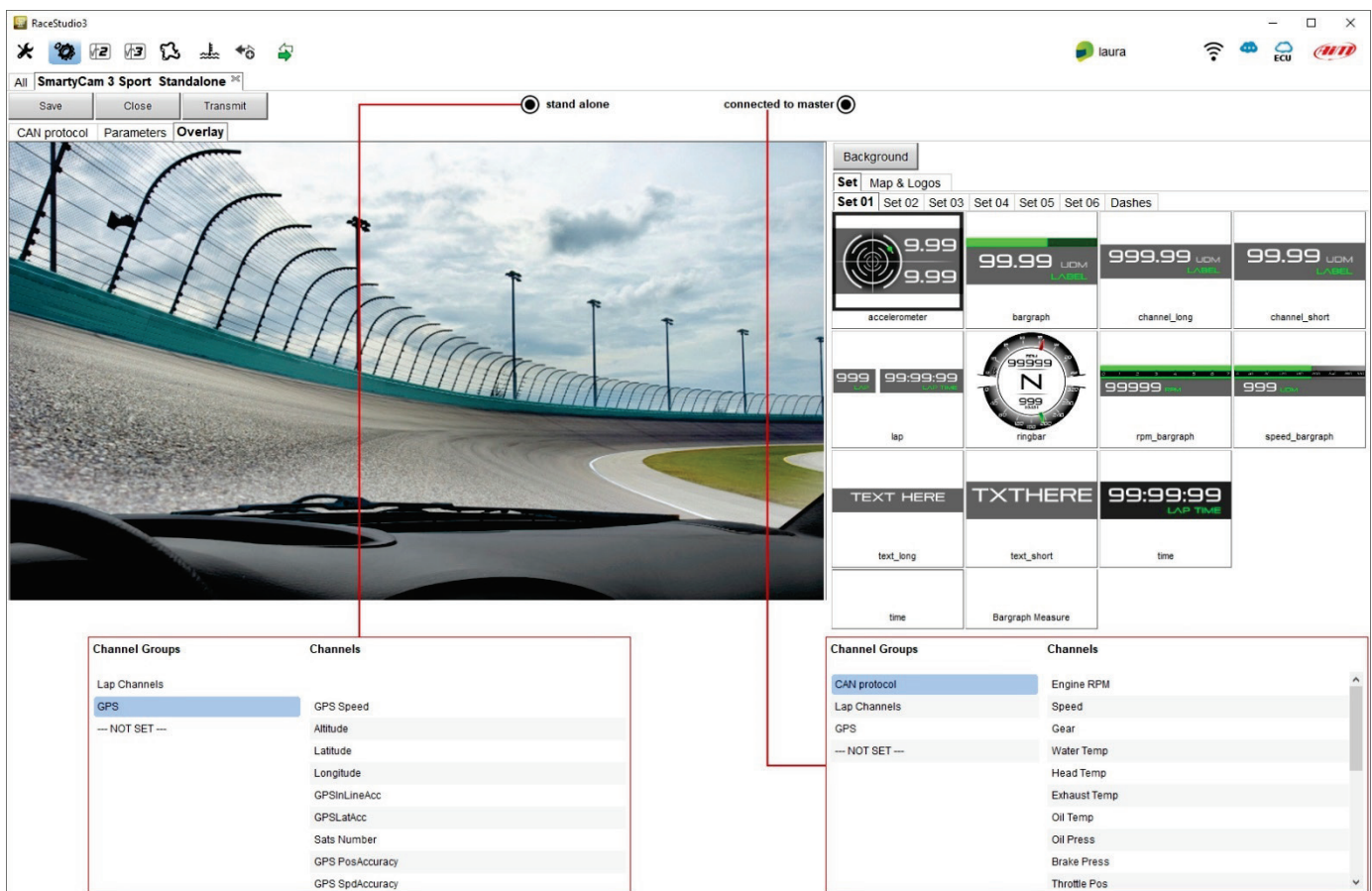

The overlays you may add to your video are:

- Graphical data
- Logo
- Track Map



You may choose among a wide set of graphical controls. Simply click on the one you prefer and drop it to the desired position in the video itself.

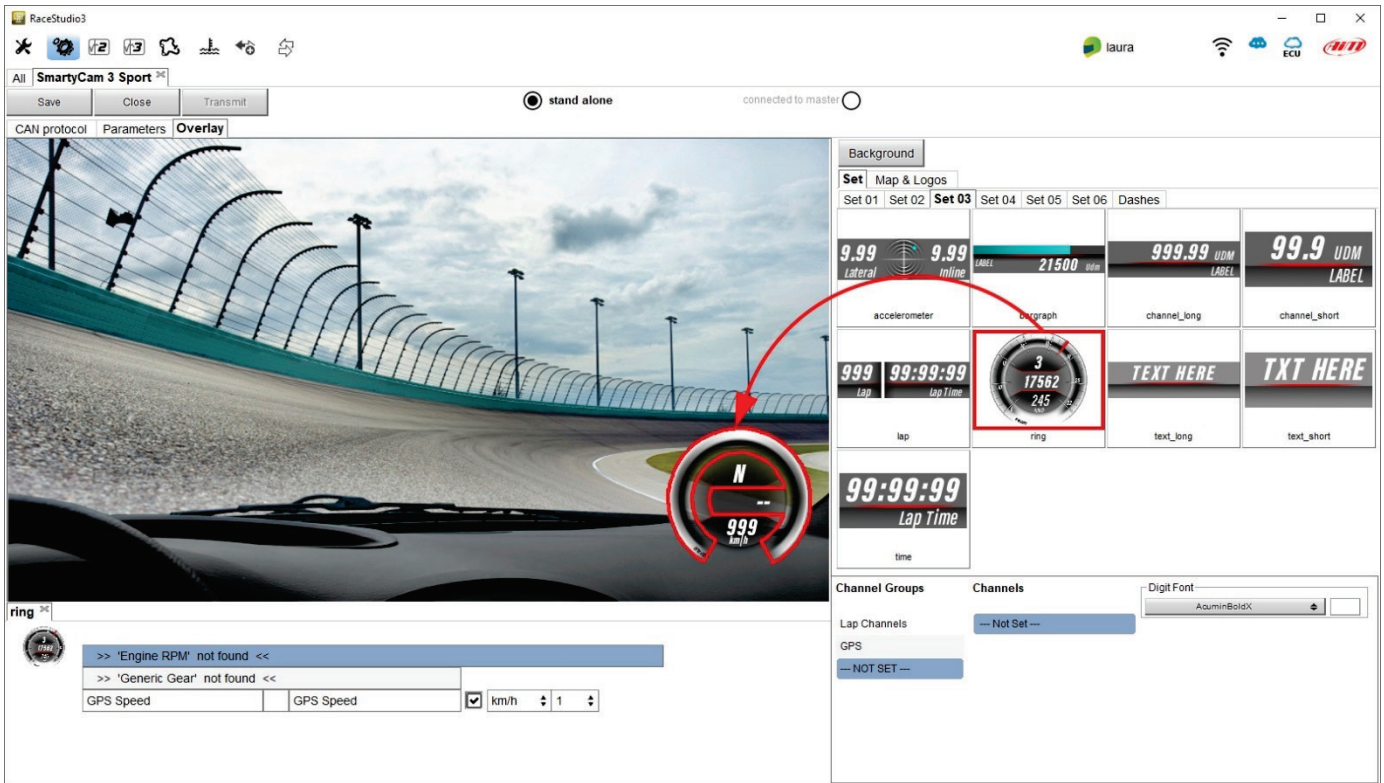

If a graphical control may show a range of possible information, you must select the appropriate channel. In the example below you are configuring a control that may show Lap Number, Lap Time, best Time, Predictive Time etc.: simply click on the desired information and you will set it.

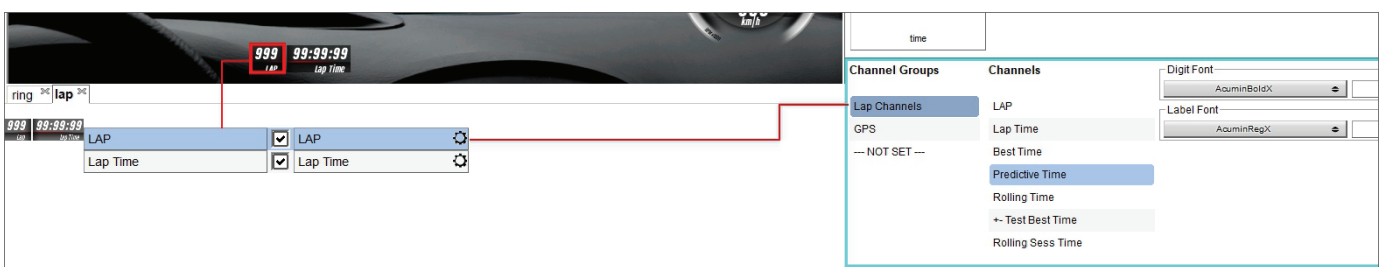

7.1.2 – Logo and MAP Setting

To add the map of the circuit or a logo to the video please click on Maps & Logos and drop the logo or the Track Map in the desired position. You may easily change shape, dimension, and position.

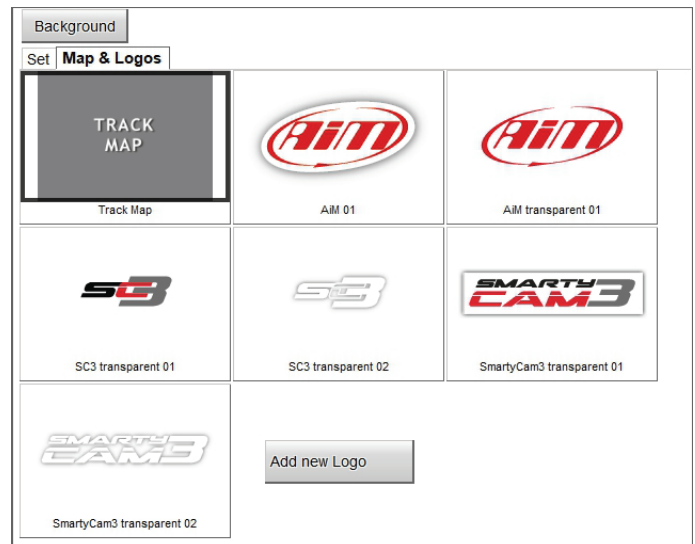

Please, note that, when configuring SmartyCam 3 Sport, you only set position and dimension of the track map while the shape of the circuit dynamically changes according to the circuit you are racing on.



7.1.3 – Configuring SmartyCam 3 Sport parameters

In case of a **Stand-Alone** installation, you may set the condition that enables SmartyCam3 Sport start recording.

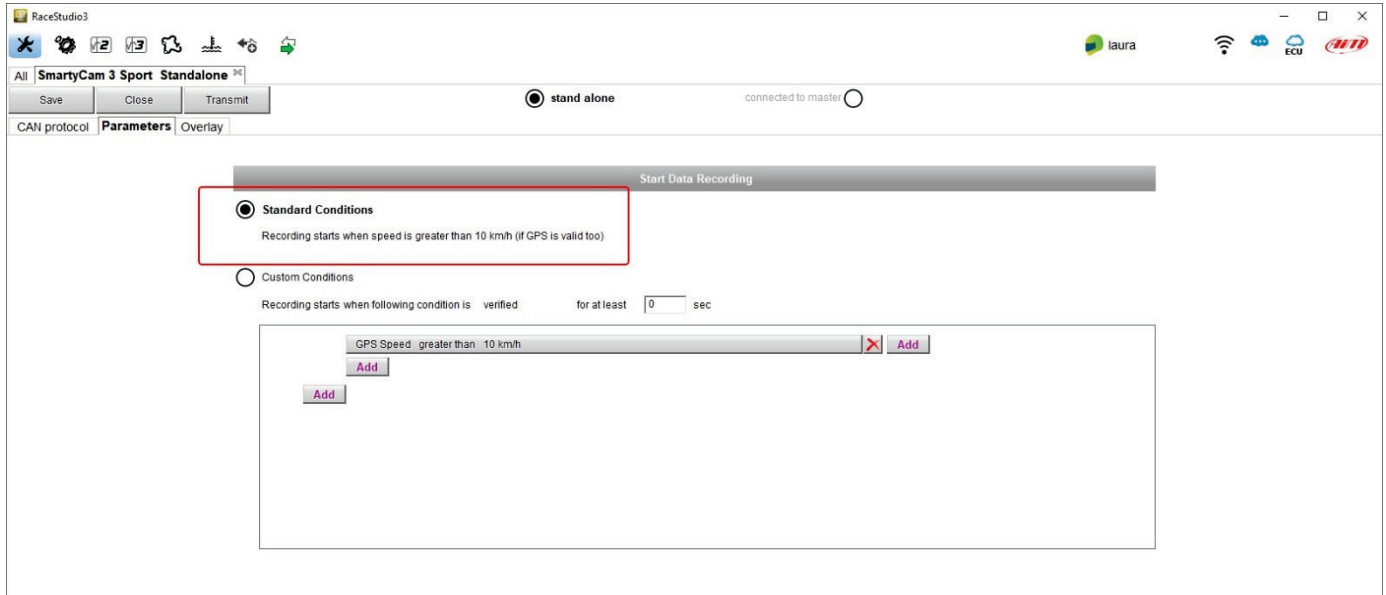

If SmartyCam 3 Sport is **connected to a Master** it starts recording when the master does.

7.1.4 –SmartyCam 3 Sport connected to a master

The connection between any AiM Logger and SmartyCam3 Sport is made through the CAN bus. The Logger transmits data to the camera in two slightly different ways:

- AiM default Protocol
- Advanced Protocol

AiM Default Protocol transmits a rather limited range of information, enough for a wide range of installations. They are shown below:

Enabled Channels (Max. 80) 20 / 20

ID	<input checked="" type="checkbox"/>	Name	Function	Unit	Freq
CC01	<input checked="" type="checkbox"/>	Engine RPM	Engine RPM	rpm	10 Hz
CC02	<input checked="" type="checkbox"/>	Speed	Vehicle Spd	km/h 0.1	10 Hz
CC03	<input checked="" type="checkbox"/>	Gear	Gear	gear	10 Hz
CC04	<input checked="" type="checkbox"/>	Water Temp	Water Temp	C 0.1	10 Hz
CC05	<input checked="" type="checkbox"/>	Head Temp	Head Temp	C 0.1	10 Hz
CC06	<input checked="" type="checkbox"/>	Exhaust Temp	Exhaust Temp	C 0.1	10 Hz
CC07	<input checked="" type="checkbox"/>	Oil Temp	Oil Temp	C 0.1	10 Hz
CC08	<input checked="" type="checkbox"/>	Oil Press	Oil Pressure	bar 0.01	10 Hz
CC09	<input checked="" type="checkbox"/>	Brake Press	Brake Press	bar 0.1	10 Hz
CC10	<input checked="" type="checkbox"/>	Throttle Pos	Pct Throttle Load	% 0.01	10 Hz
CC11	<input checked="" type="checkbox"/>	Brake Pos	Pct Brake Load	% 0.01	10 Hz
CC12	<input checked="" type="checkbox"/>	Clutch Pos	Percent	% 0.01	10 Hz
CC13	<input checked="" type="checkbox"/>	Steering Pos	Steering Pos	deg 0.1	10 Hz
CC14	<input checked="" type="checkbox"/>	Lambda	Lambda	lambda 0.01	10 Hz
CC15	<input checked="" type="checkbox"/>	Lateral Acc	Lateral Accel	g 0.01	10 Hz
CC16	<input checked="" type="checkbox"/>	Inline Acc	Inline Accel	g 0.01	10 Hz
CC17	<input checked="" type="checkbox"/>	Fuel Level	Pct Fuel Level	% 0.01	10 Hz
CC18	<input checked="" type="checkbox"/>	Battery Voltage	Voltage	mV	10 Hz
CC19	<input checked="" type="checkbox"/>	Vertical Acc	Vertical Accel	g 0.01	10 Hz
CC20	<input checked="" type="checkbox"/>	Logger Temp	Temperature	C 0.1	10 Hz

If you wish to transmit a different set of information, you may do as follows:

- Configure your Logger in order to transmit a different SmartyCam Stream
- Select the desired SmartyCam Stream in SmartyCam 3 Sport configuration

Follow the steps shown in the following figures:

- select “Advanced” option in SmartyCam Stream layer when you configure the Logger.

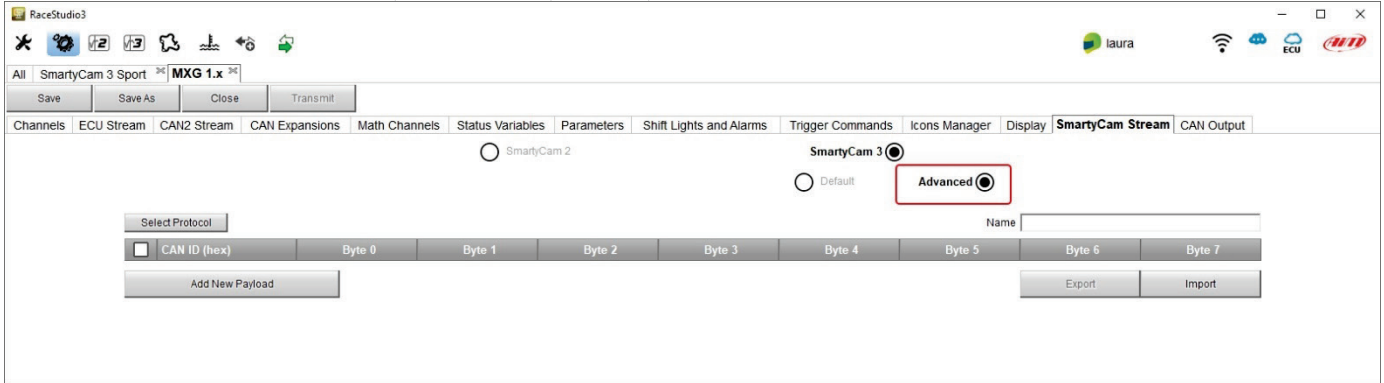

- Create your desired Stream, defining the required IDs and fields
- Name the protocol and save it

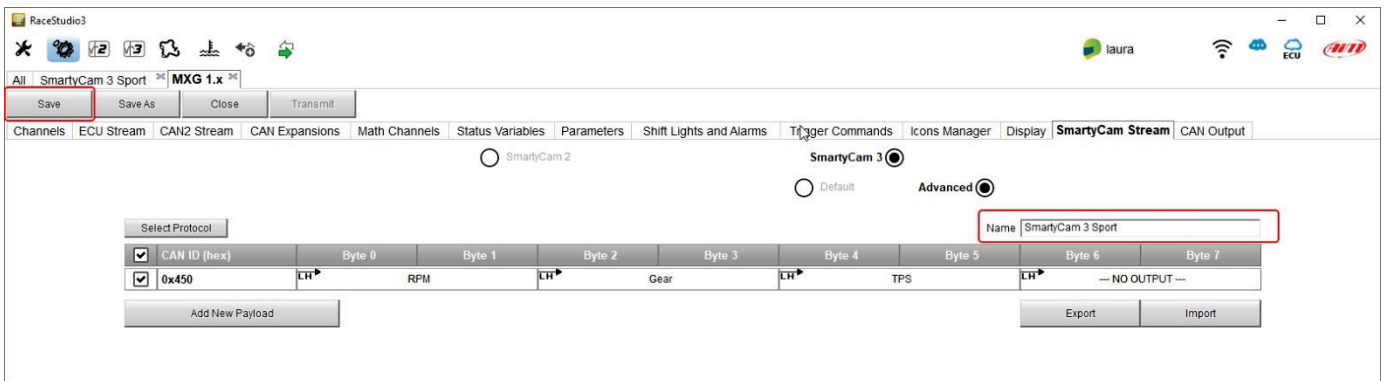

- Once the Logger configuration saved, you may import the protocol in SmartyCam 3 Sport configuration and use the channels as required.

Please, note that ALL data transmitted to SmartyCam3 Sport are stored as metadata directly in the .mp4 file in order to be analysed by RaceStudio3 Analysis

The screenshot shows the RaceStudio3 interface with the 'Select Protocol' dialog box open. The dialog box is titled 'Select AIM SmartyCam3 Stream Protocol' and contains a table with columns 'Protocol name' and 'Configuration'. The 'Protocol name' is 'SmartyCam 3 Sport' and the 'Configuration' is 'MXG 1.x'. The background shows the 'Enabled Channels' list with 20 channels checked.

ID	Name	Unit	Resolution	Frequency
CC01	Engine R			
CC02	Speed			
CC03	Gear			
CC04	Water Temp			
CC05	Head Temp			
CC06	Exhaust Temp			
CC07	Oil Temp	Oil temp	C 0.1	10 Hz
CC08	Oil Press	Oil Pressure	bar 0.01	10 Hz
CC09	Brake Press	Brake Press	bar 0.1	10 Hz
CC10	Throttle Pos	Pct Throttle Load	% 0.01	10 Hz
CC11	Brake Pos	Pct Brake Load	% 0.01	10 Hz
CC12	Clutch Pos	Percent	% 0.01	10 Hz
CC13	Steering Pos	Steering Pos	deg 0.1	10 Hz
CC14	Lambda	Lambda	lambda 0.01	10 Hz
CC15	Lateral Acc	Lateral Accel	g 0.01	10 Hz
CC16	Inline Acc	Inline Accel	g 0.01	10 Hz
CC17	Fuel Level	Pct Fuel Level	% 0.01	10 Hz
CC18	Battery Voltage	Voltage	mV	10 Hz
CC19	Vertical Acc	Vertical Accel	g 0.01	10 Hz
CC20	Logger Temp	Temperature	C 0.1	10 Hz

7.4 – Loading the configuration to SmartyCam 3 Sport

After having created the configuration, you have to load it to your SmartyCam 3 Sport:

- press “Save” button top left of the page
- insert a MicroSD in the PC slot
- press “Transmit” button; the software recognizes the MicroSD and send the configuration to it
- remove the MicroSD from the PC slot
- insert it in SmartyCam3 Sport slot
- follow this path: “MENU” -> “UPDATE” -> “CONF LOAD” and load the configuration to SmartyCam 3 Sport

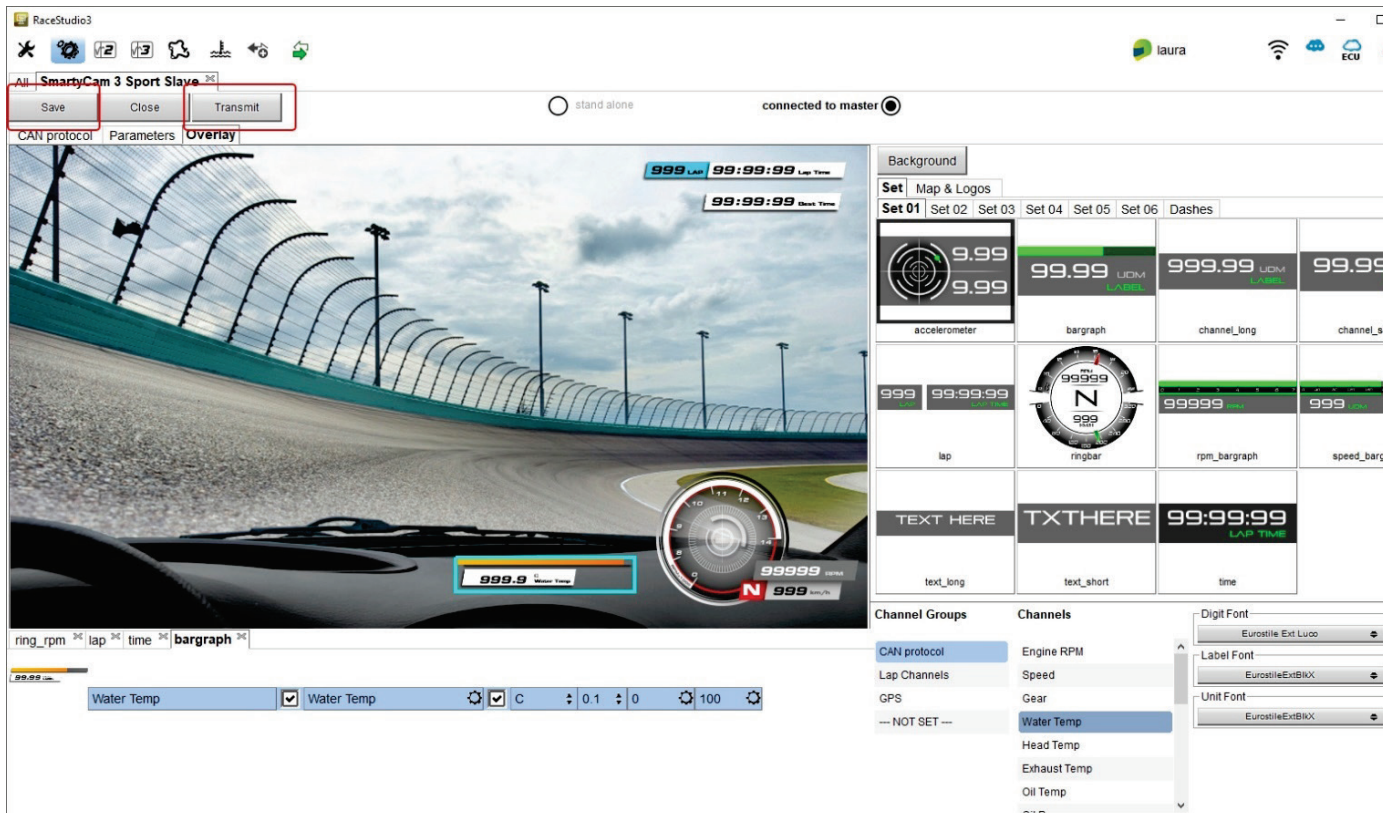

7.5 – Track Management

Track Manager is the Race Studio 3 section dedicated to tracks management. Here you can create and delete new tracks, modify the settings as well as load them to SmartyCam 3 Sport microSD. To access, press “Tracks” icon on Race Studio 3 top left keyboard.



The main page is divided in three columns: on the **Left**:

- on top, the filters to collect the tracks; by default all tracks are shown – “All Tracks (5327)” in the image below. The filters are:
 - nations: select the nation you want to see the tracks of
 - smart collections: clicking the setting icon a panel that allows to select continent, nation, circuit type and road surface is prompted; select the criteria you wish and name the collection specifying the used filter if you like it
 - manual: clicking the setting icon a new collection panel is prompted: name it and drag and drop the tracks in it
- bottom the connected devices in the image SmartyCam 3 Sport microSD “SmartyCam 3 Sport ID 4111112 [TEST-2 – D:]”

The column **in the middle** shows:

- on top a fast search bar, that allows to select the tracks which satisfy personal research criteria; pressing “?” a tooltip explains the research criteria (highlighted in red below); to say:
 - track long name contains.....: long name is the name in bold in each track box
 - track short name contains.....: short name is the track name shown top right of each track box
 - track city begins with....: is the name of the city the track is located in
- all the tracks listed in Race Studio 3 database. It automatically updates at start up if a connection to the Internet is available.

The column on the **Right** shows two tabs:

- the data sheet of the track you are mousing over and
- its weather forecast if available.

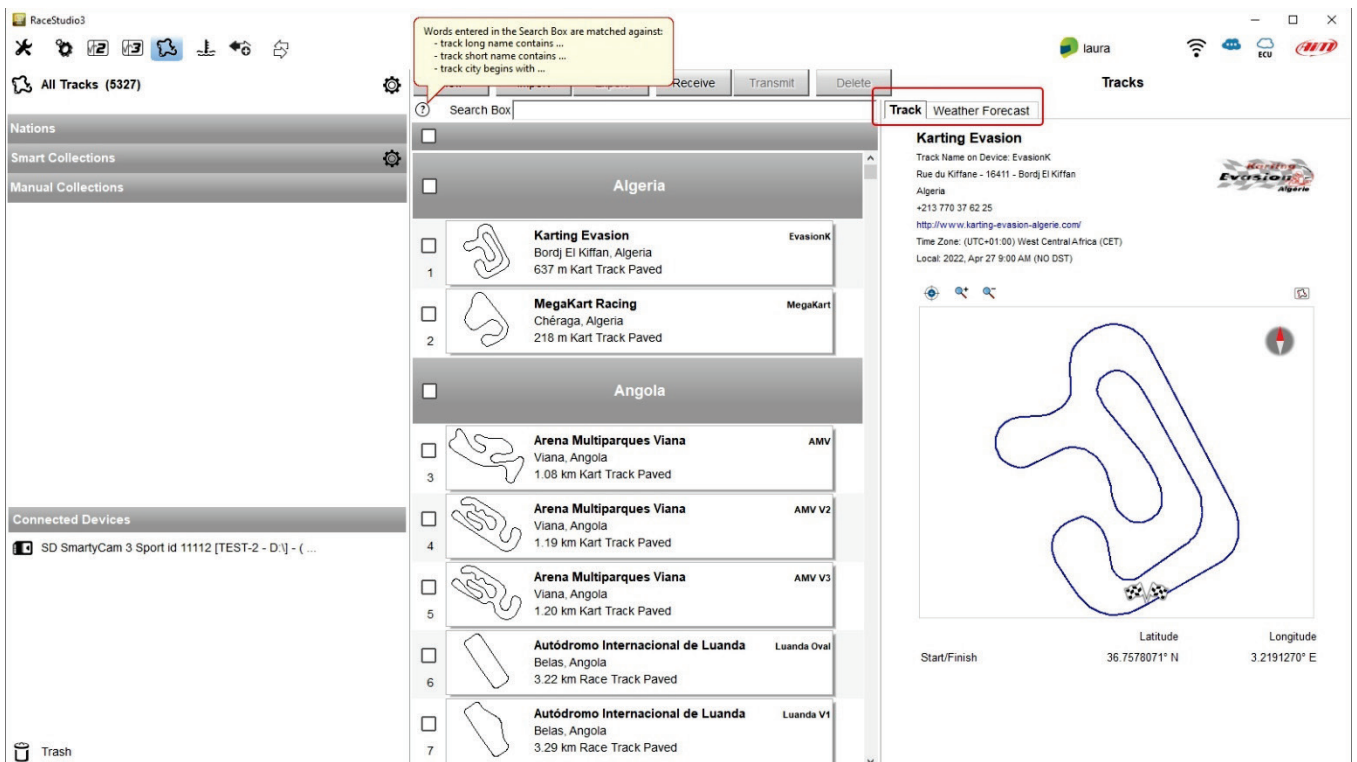

SmartyCam 3 Sport microSD is shown left bottom of the page; clicking it tracks stored are shown right on the page. Tracks created by the user are labelled "User"; any difference among tracks stored in SmartyCam 3 Sport microSD and the same stored in AiM database is notified.

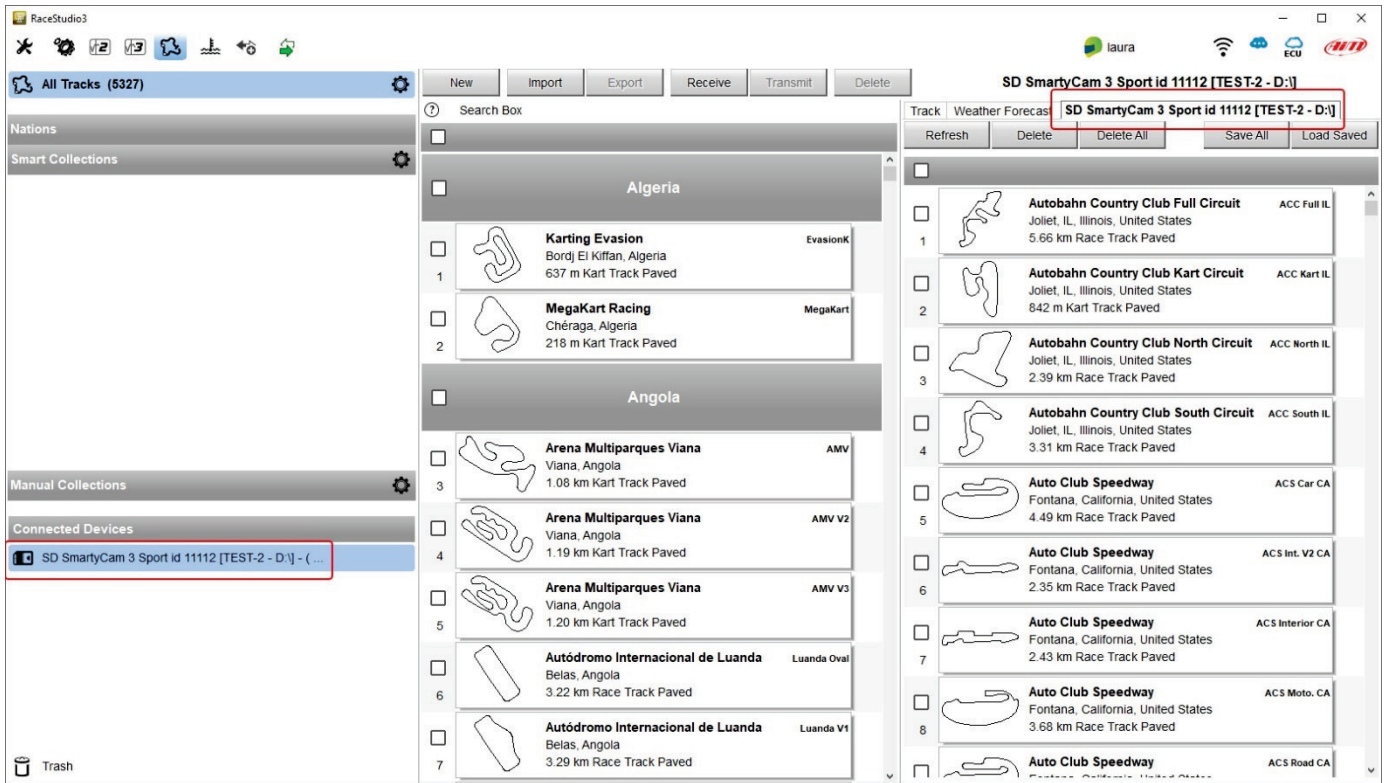

The page keyboards are for:

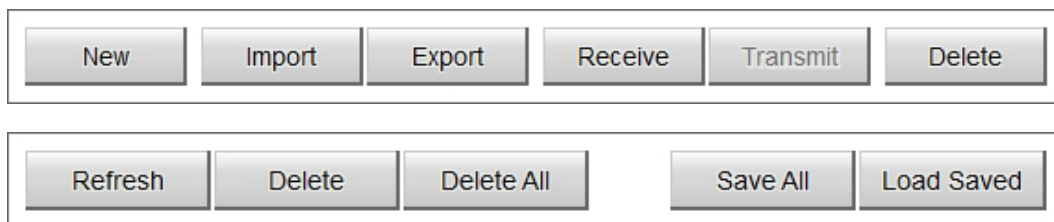

- **New:** create a new track
- **Import:** import one or more tracks stored in SmartyCam 3 Sport or on another external device
- **Export:** export one or more tracks to a specific PC folder or to another peripheral device
- **Receive:** receive from SmartyCam 3 Sport the tracks created by the user (if no device is connected the button is disabled)
- **Transmit:** transmit one or more tracks from the PC to SmartyCam 3 Sport (if no device is connected the button is disabled)
- **Delete:** delete one or more tracks from Race Studio 3 Database

- **Refresh:** refresh the track list stored in SmartyCam 3 Sport
- **Delete:** delete one or more tracks from SmartyCam 3 Sport microSD
- **Delete All:** delete all tracks stored in SmartyCam 3 Sport microSD
- **Save all:** save all the tracks stored in SmartyCam 3 Sport microSD; it creates a zip file that can be loaded to another AiM device
- **Load Saved:** load the tracks previously saved in SmartyCam 3 Sport microSD

Please note: for further information about Race Studio 3 Track Management visit www.aim-sportline.com documentation area, software/firmware section where a Track Manager manual is available.

7.6 – Video Management

Once a track session is over it is possible to review SmartyCam 3 Sport video on a PC:

- remove microSD card from the camera
- place it in the PC slot and manage it as an USB peripheral
- run Race Studio3 software
- click on the microSD bottom left of the software page
- the list of the video stored in the microSD is prompted right of the page
- press “Download” button on the top keyboard
- fill in the panel that is prompted
- press “OK”

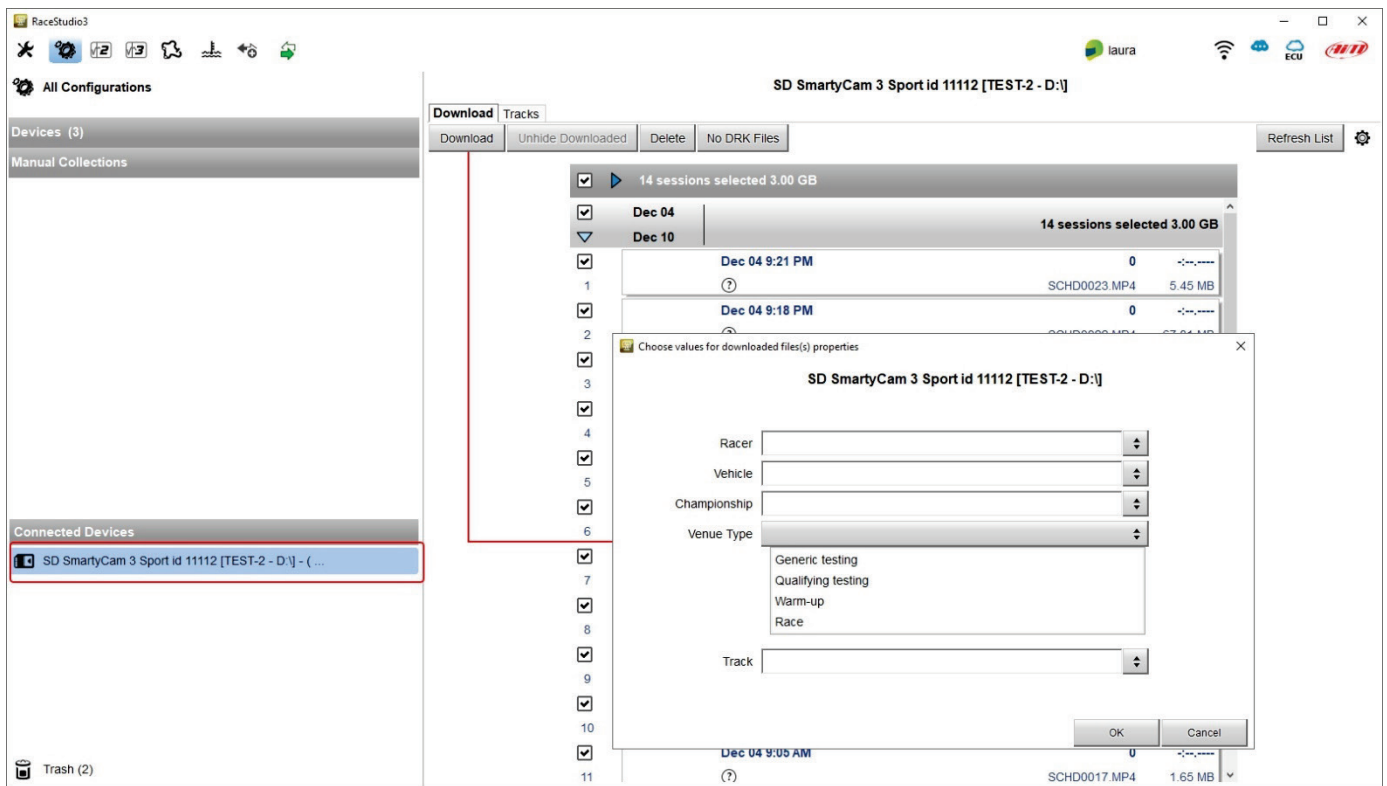



Video download starts.

The screenshot shows the RaceStudio3 interface with a download window open for 'SD SmartyCam 3 Sport id 1400109 [SC3TEST1 - D:]'. The window has a 'Download' tab and buttons for 'Cancel', 'Unhide Downloaded', 'Delete', and 'No DRK Files'. A 'Refresh List' button is also present. The main area shows a list of 14 sessions selected, totaling 3.00 GB. The sessions are listed with their start times and file sizes.

Session ID	Start Time	File Name	Size
1	Dec 04 9:21 PM	SCHD0023.MP4	5.45 MB
2	Dec 04 9:18 PM	SCHD0022.MP4	67.81 MB
3	Dec 04 6:20 PM	SCHD0021.MP4	51.98 MB
4	Dec 04 5:01 PM	SCHD0031.MP4	1.25 GB
5	Dec 04 3:12 PM	SCHD0030.MP4	24.23 MB
6	Dec 04 3:10 PM	SCHD0029.MP4	24.56 MB
7	Dec 04 3:09 PM	SCHD0028.MP4	82.77 MB
8	Dec 04 3:07 PM	SCHD0027.MP4	19.82 MB
9	Dec 04 2:58 PM	SCHD0026.MP4	43.08 MB
10	Dec 04 2:57 PM	SCHD0025.MP4	4.82 MB
11	Dec 04 9:05 AM	SCHD0017.MP4	1.65 MB



When all files have been downloaded run Race Studio3 Analysis and the video just downloaded are prompted in the central column of the page. Click on any video to start watching it.

Please refer to RaceStudio3 Analysis user manual for any further information concerning the software working mode.

The screenshot displays the RaceStudio3 software interface. On the left, a sidebar lists 'All Events (96 sessions of 96)' with columns for '#', 'Date', and 'Track'. Below this are sections for 'Recent Sessions', 'Smart Collections', and 'Manual Collections'. The main window shows a table of lap data for the date '2022, April 27'. The table has columns for Lap(s), Best, Venue, Vehicle, and Track. A summary table above the main table shows Lap 1 with a Time of 0:13.6310, Pct of inf, Min of 0.2, and Avg of 1.0. Below the table is a line graph titled 'GPS Speed (km/h)' vs 'Time [s]', showing speed fluctuations between 0.0 and 2.2 km/h over time.

Lap	Time	Pct	Min	Avg
1	0:13.6310	inf	0.2	1.0



8 – Technical specifications and drawings

Video format	H264 – 1920x1080 pixels at 30 fps
Display resolution	128x128 pixels
Lens	Low distortion camera lens
CMOS Sensor	Global shutter
Field of view	67° or 84°
External power	9-15V
Supported microSD Card (not included)	up to 2Tb
Connector	1 Binder 712 female
Working temperature range	-10°C/+50°C
Auto power ON	Yes
Auto power OFF	Yes
Auto Start/Stop recording	Yes
Body	Nylon fiberglass charged and coated aluminium
Dimensions	79.9x54x46.5
Weight	200g battery included
Waterproof	IP65



SmartyCam 3 Sport dimensions in mm [inches]

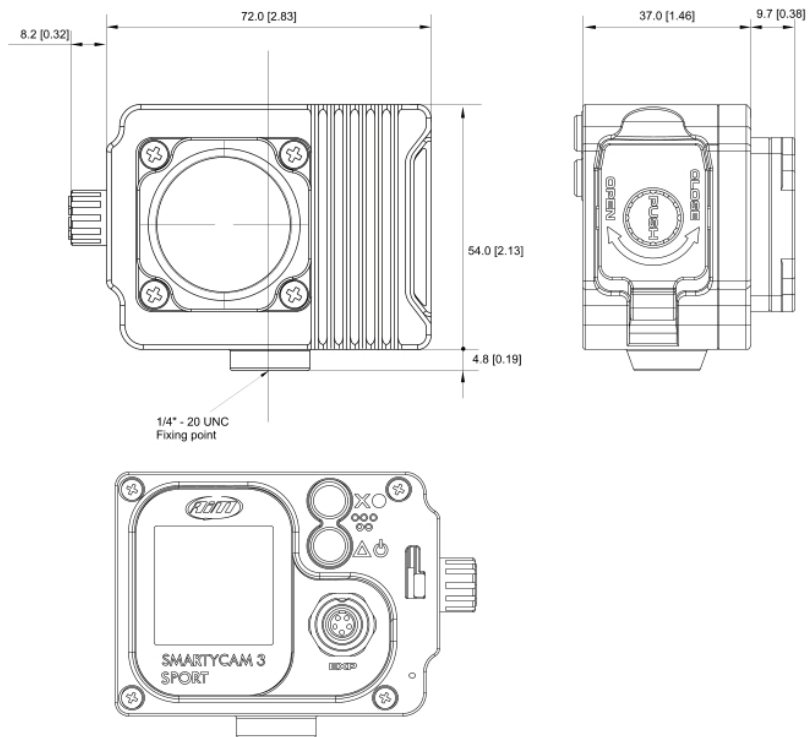

SmartyCam 3 Sport pinout

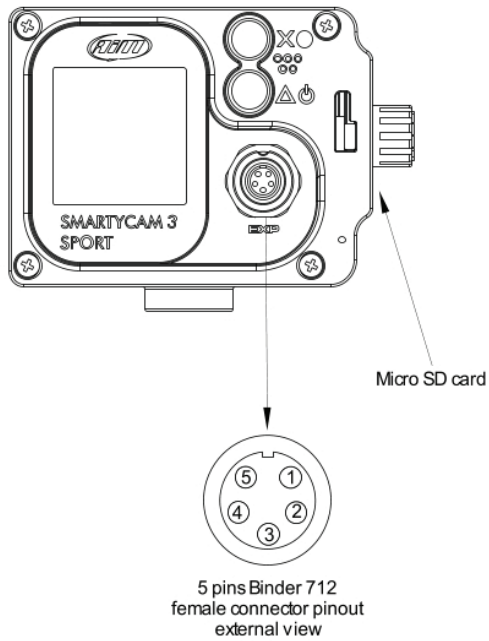

EXP	
1	CAN+
2	GND
3	+Vb out
4	CAN-
5	+Vb ext