

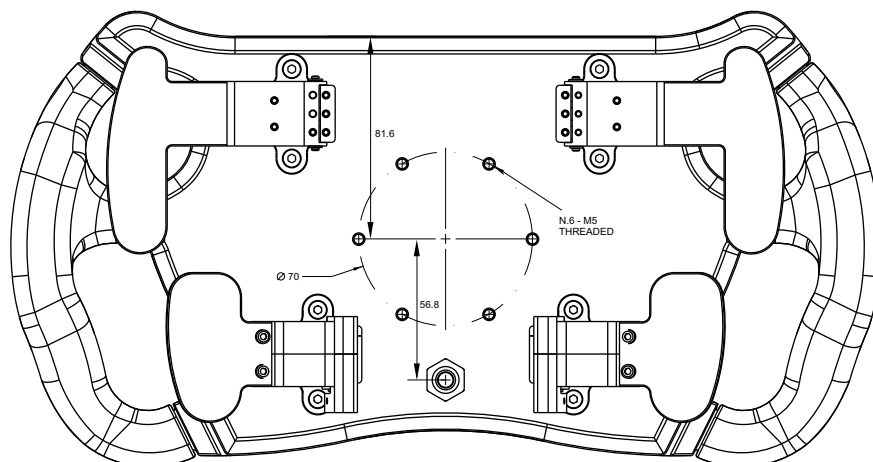

AiM SW4 350

Steering Wheel

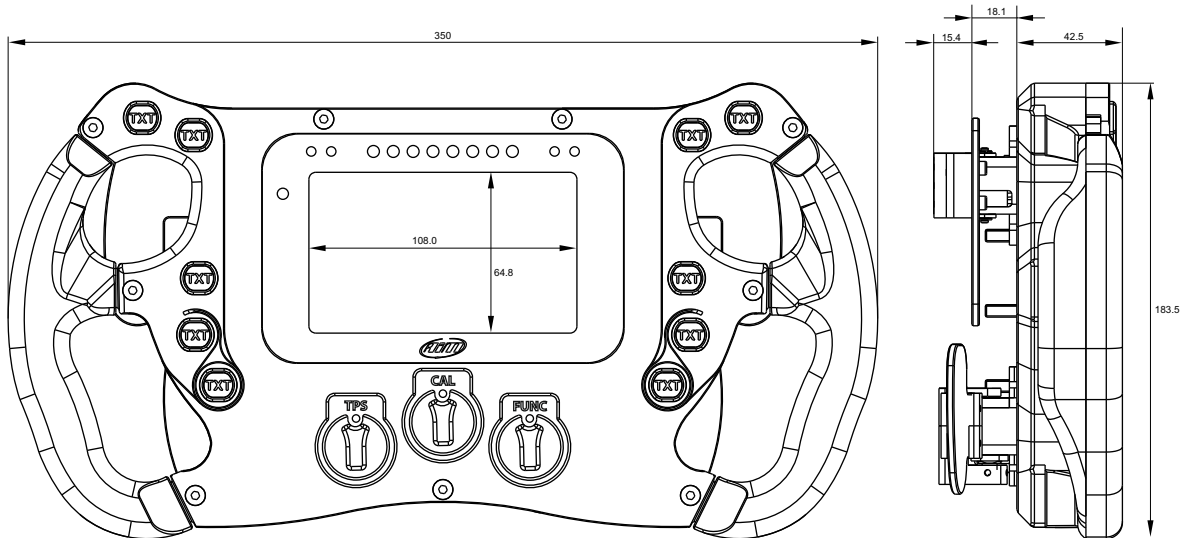



AiM SW4 350

Steering Wheel

Technical specifications

Display	5" TFT
Resolution	800x480 pixels
Contrast	800:1
Brightness	800 cd/m2 - 1,200 Lumen
Ambient light sensor	Yes
Alarm display icons	Yes, freely configurable
Shift Lights	8 configurable RGB LEDs
Alarm LEDs	4 configurable RGB LEDs
CAN connections	3
ECU connection	CAN
ECU compatibility	1,000+ industry leading ECUs
Expansion CAN connection	GPS Module, Channel Expansion, TC Hub, Lambda Controller, SmartyCam HD RIO02, GS Dash, Memory Module
Internal memory	4 GB
Body	Anodized Aluminum
Pushbuttons	10 pushbuttons + 3 rotary switches (all with RGB backlights)
Connectors	1 Deutsch Autosport 22 pin male connector
Dimensions	350 x 183.5 x 42.5 mm
Weight	2,600 g
Power consumption	500 mA
Waterproof	IP65



AiM SW4 350

Steering Wheel

Pinout

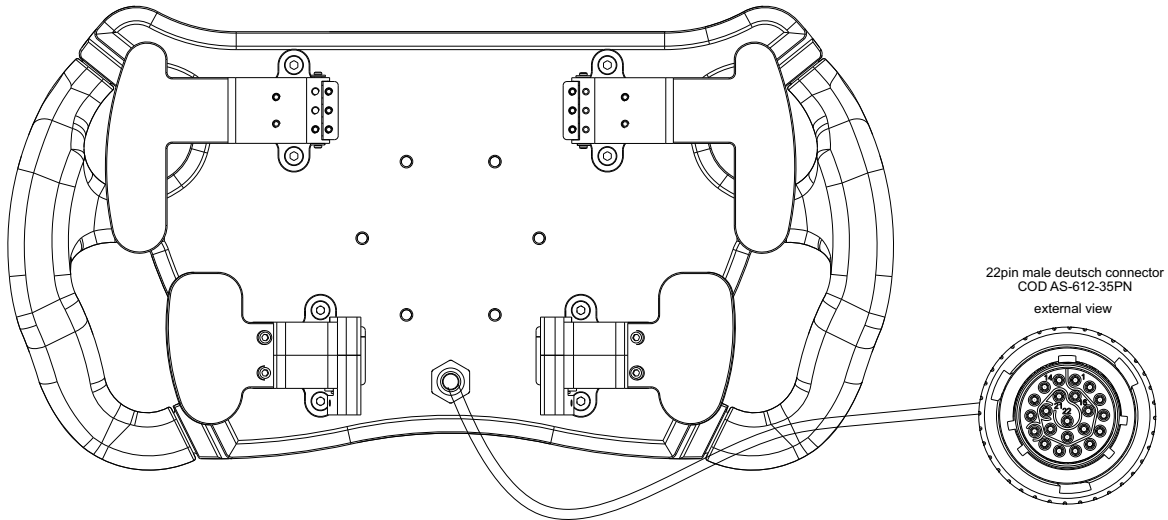

PIN	SIGNAL
1	9-15V Power in
2	CAN ECU+
3	CAN ECU-
4	Paddle sh Left
5	Paddle sh Right
6	Paddle sh COM
7	Function button 2
8	CAN 2+
9	CAN 2-
10	Function button 1
11	USB D+
12	USB D-
13	CAN AIM+
14	GND
15	CAN AIM -
16	RPM
17	NC
18	Function button 2
19	GND
20	Function button 1
21	+Vbext CAN
22	+Vbout CAN

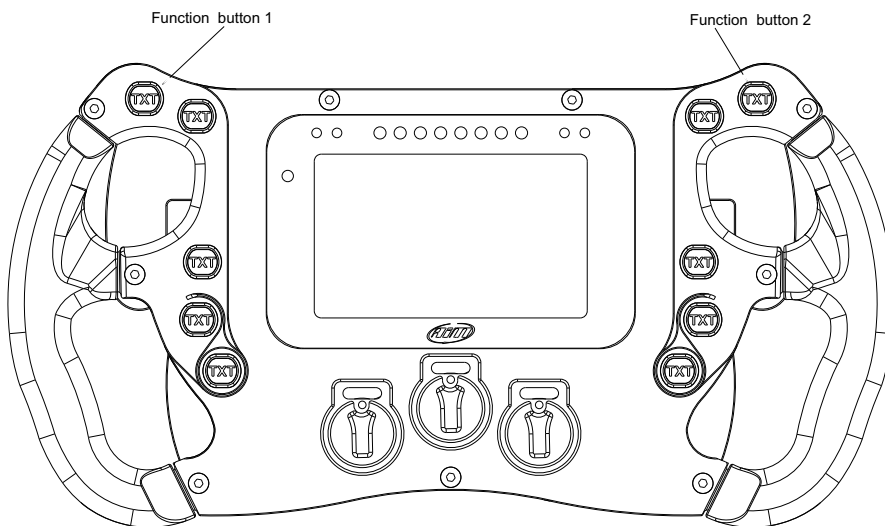

All other push buttons and all rotary switches on CAN BUS